

Data Sheet

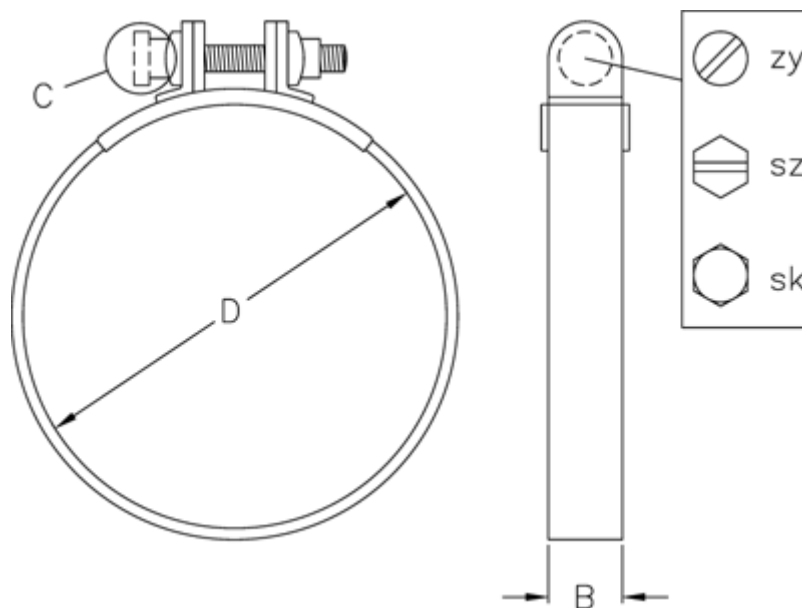

Article number: 02140000030
Description: Sealing Clamp S 30 W1

Measures



C (screw type) = SZ
Diameter D = 30
Width B = 15